

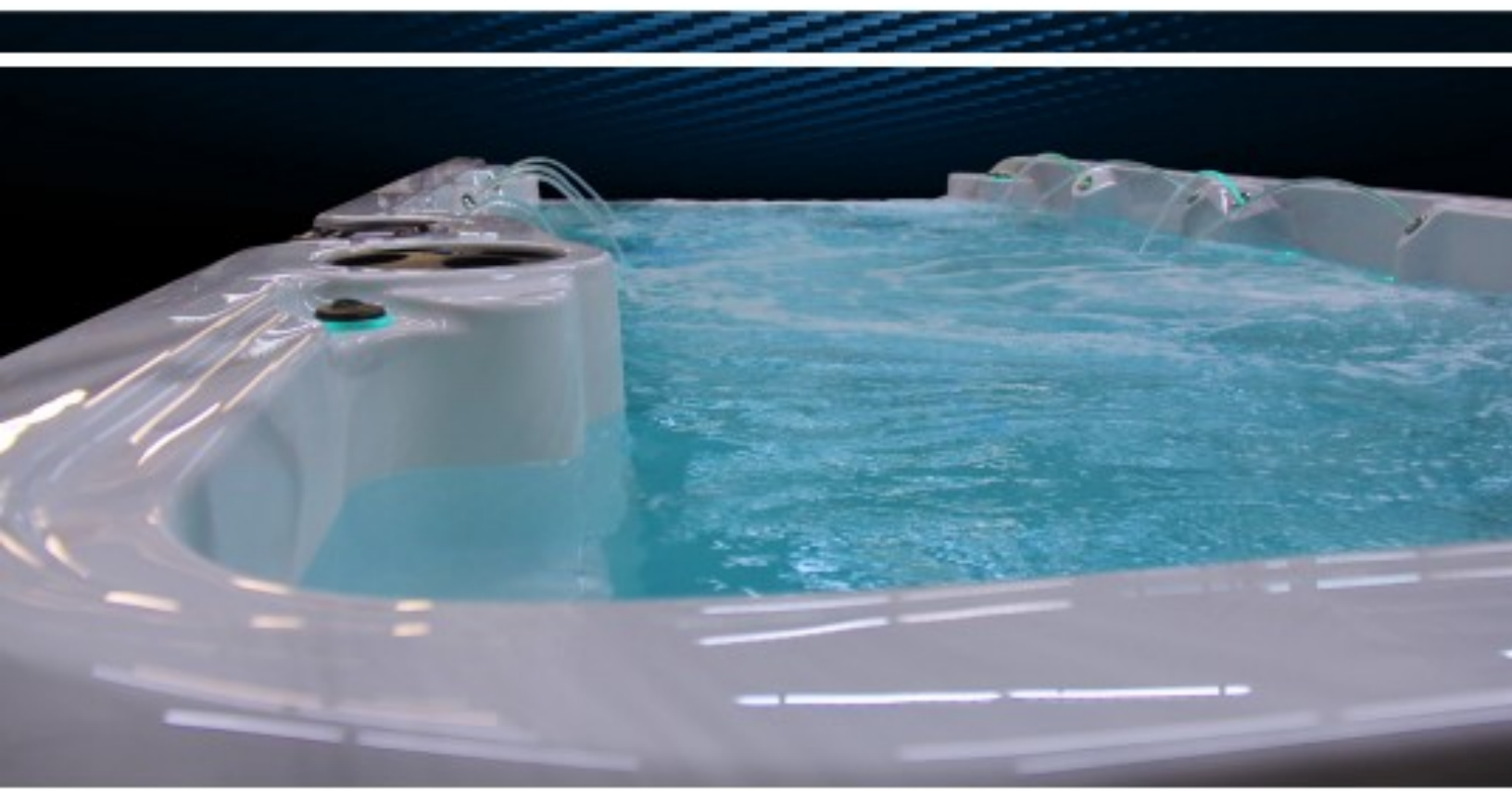

INFINITY



— 2018 —  
**OWNER'S MANUAL**

Coast Spas Manufacturing Inc.  
6315 202 Street, Langley BC Canada  
604 514 8111  
info@coastspas.com  
www.coastspas.com

**TABLE OF CONTENTS**

<b>Basic Information</b>	<i>Page</i>	<b>3</b>
<b>Quick Start Guide</b>	<i>Page</i>	<b>4</b>
<b>Important Safety Instructions</b>	<i>Page</i>	<b>5</b>
<b>Preparation and Set-up for Your New Spa</b>	<i>Page</i>	<b>6</b>
<b>Electrical Requirements</b>	<i>Page</i>	<b>6</b>
<b>Draining &amp; Winterizing</b>	<i>Page</i>	<b>7</b>
<b>Filter Maintenance</b>	<i>Page</i>	<b>8</b>
<b>Water Quality Maintenance</b>	<i>Page</i>	<b>8</b>
<b>Water Clarity Troubleshooting</b>	<i>Page</i>	<b>9</b>
<b>Product &amp; Care Guide</b>	<i>Page</i>	<b>10</b>
<b>Glossary of Terms</b>	<i>Page</i>	<b>11-12</b>
<b>Basic Installation and Configuration Guidelines</b>	<i>Page</i>	<b>12</b>
<b>Troubleshooting Guide</b>	<i>Page</i>	<b>13-14</b>
<b>Spa Controls</b>	<i>Page</i>	<b>15-24</b>
<b>Spa Panel Removal Instructions</b>	<i>Page</i>	<b>25</b>



## CONGRATULATIONS!

YOU'RE ALMOST READY TO ENJOY YOUR NEW SPA!

**! PLEASE READ YOUR ENTIRE OWNER'S MANUAL BEFORE SPA OPERATION !**

### Basic Information

#### Water Care



**IMPORTANT:** Caring for your water by ensuring proper chemical usage is the single most important thing you can do to keep your hot tub in good condition.

**WARNING:** Improper chemical usage and maintenance will quickly lead to severe issues with your spa and can effect the spas equipment, jets, pumps and all other components in contact with the spa water. **All hot tubs and swim spas are susceptible to damage from unbalanced spa water.**

Always maintain your spa's water chemistry within the following parameters:

pH	7.2 - 7.8
Chlorine	1.0 - 3.0 ppm
Bromine	2.0 - 5.0 ppm
Total Alkalinity	100 - 120 ppm
Calcium Hardness	150 - 250 ppm

#### Electrical

**All self contained spas use 120VAC or 240VAC electrical spa packs.**



**120VAC:** Requires an isolated 20 Amp circuit breaker, an isolated circuit with no other appliances or lights on the circuit at any time. Extension cords are not to be used in conjunction with the operations of the spa. Low voltage damage could result and this is not covered by warranty. **IMPORTANT: Hot Tubs with 110V means that the jets and heater will not work at the same time.**

*NOTE: All components must be 120V. No 240V components allowable.*



**240VAC:** Depending on the model of spa, it will require either a 40 Amp or 50 Amp dedicated circuit breaker, GFCI, with the proper wire size based on the length of the run.

**The electrical circuit must be installed by a certified electrician and approved by a local building or electrical inspector.**

#### Surface



Your new portable spa must be placed on a firm, flat and level surface, so the spa weight is supported uniformly. We recommend no less than a 3" (93 mm) thick concrete slab. Wood decking or balconies must be constructed to support 150 pounds per square foot (730 kg/m<sup>2</sup>). Refer to local and current building codes in your area. Consult an engineer for live loads in your area. Should your new spa need to go through a gate, the opening should be a minimum of 48 inches and up to 8.5' overhead clearance depending on the size of the unit.

*NOTE: Damage caused by alternate decking methods may avoid the spa warranty. Contact your dealer if you have any questions regarding spa location or placement.*

#### Transport



Your new spa has left the factory cleaned and polished and ready to begin operation after passing our many quality and operational tests. However, depending on your location in the world, your spa may have spend days or even weeks in transit before arriving at your home. Please ensure that before filling or operating your hot tub that you check all electrical and plumbing connections are securely connected in the equipment area as they might have loosened during shipping. If any dirt has accumulated, you will want to remove with a clean cloth or sponge using warm water.

### PREP FOR FILLING

**! PLEASE READ ALL INSTRUCTIONS BELOW BEFORE FILLING THE SPA**



Using a cloth and water, wipe away any dirt/dust collected from transport. Ensure all jets are open by turning the face counter clockwise.

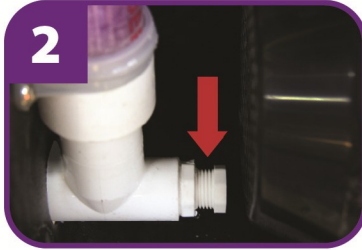

If your spa has a Crystal Clear tube the threaded plug needs to be on prior to filling the spa.



Remove the filter lock ring and lid. Remove filter and take it out of the plastic transport bag.



Put the filter back inside and secure the lid firmly with the locking rig. Loosen air-bleed screw.

### FILLING YOUR SPA

**! DO NOT USE HOT WATER TO FILL YOUR SPA**

**! DO NOT USE WATER FROM A WATER SOFTENER**



Place fill hose inside the spa and fill main body of spa with water until it reaches the infinity edge. Allow water to spill over infinity edge for approximately 60 seconds.



Tighten air-bleed screw.



Turn power to the spa on from GFCI breaker to activate water level gauge. Continue filling until the water gauge reads just above 1/2 full.



Turn power to the spa off from the GFCI breaker for 30 seconds and then turn back on.

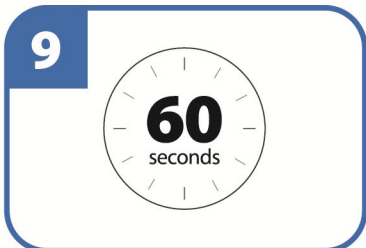

Do not press the back and/or pump #1 button on the control panel. Activate high speed on pumps 2 & 3 (if 3-pump model) or pump 2 (if 2-pump model) by pressing the pump buttons twice. Let run for 60 seconds.

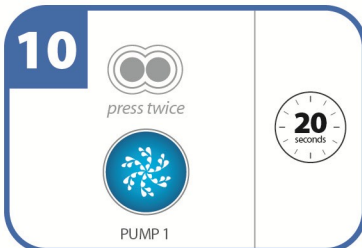

Continue running pumps 2 & 3 (pump 2 on 2-pump models), turn pump 1 on high speed for 20 seconds by pressing the pump 1 icon twice.

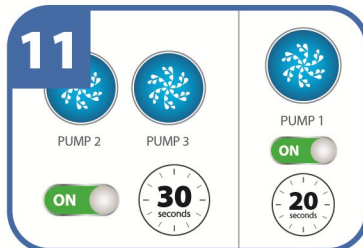

Continue running pumps 2 & 3 (pump 2 on 2-pump models) on high speed for 30 seconds and activate pump 1 on high speed for 20 seconds.



Cascade check valve inside the equipment area, full of water is an indication of no more air in the plumbing line. If the check valve is not full of water, air is still in the plumbing lines.



Release any additional trapped air by loosening the air bleed screw. Wait for all air to be released. Retighten.

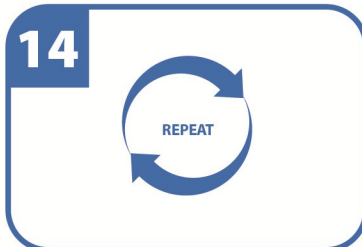

Repeat steps 11-12 until all air has been removed from the system. If air is still in the system it will precede water coming out of the jets when pump 1 is activated.

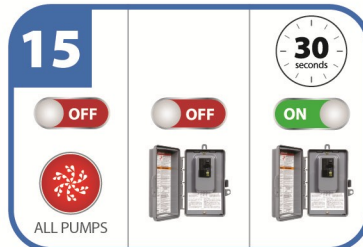

Turn off all pumps. Then turn main power off to the spa for 30 seconds. Then turn power back on.

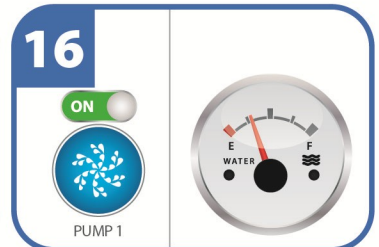

Your water level should read just above 1/4 on the gauge when pump 1 (high speed) is activated. **Your hot tub is now filled. Set the temperature and get ready to enjoy!**

**IMPORTANT SAFETY INSTRUCTIONS**

**READ AND FOLLOW ALL INSTRUCTIONS CAREFULLY**

**DANGER:** Risk of Injury. The suction fittings in this hot tub are sized to match the specific water flow created by the pump. Should the need arise to replace the suction fittings or the pump, be sure that the flow rates are compatible. Never operate the hot tub if the suction fittings are broken or missing. Never replace a suction fitting with one rated less than the flow rate marked on the original suction fitting.

**DANGER:** Risk of Accidental Drowning. Do not allow children to be in or around the spa without adult supervision. Keep the spa cover on and locked when not in use. See instructions enclosed with the cover for locking procedures.

**DANGER:** Risk of Electrical Shock. The electrical supply for this product must include a suitably rated switch or circuit breaker to open all ungrounded supply conductors to comply with section 422-20 of the National Electrical Code, ANSI/NFPA 70. The disconnect must be readily accessible and visible to the hot tub occupant but installed at least 5 feet (1.5 m) from the hot tub water.

**READ, FOLLOW AND SAVE THESE INSTRUCTIONS**

- a) A green colored terminal or a terminal marked G, Gr, Ground, Grounding or the symbol \* is located inside the supply terminal box or compartment. To reduce the risk of electric shock, this terminal must be connected to the grounding means provided in the electric supply service panel with a continuous copper wire equivalent in size to the circuit conductors that supply this equipment.
- b) At least two lugs marked "Bonding Lugs" are provided on the external surface or on the inside of the supply terminal box compartment. To reduce the risk of electric shock, connect the local common bonding grid in the area of the hot tub to these terminals with an insulated or bare copper conductor not smaller than No. 6 AWG.
- c) All field-installed metal components such as rails, ladders, drains or other similar hardware within 5 feet (1.5 m) of the hot tub shall be bonded to the equipment grounding buss with copper conductors not smaller than No. 6 AWG.

**WARNING:** To Reduce the Risk of Injury: The water in a hot tub should never exceed 104 °F (40 °C). Water temperatures between 100 °F (38 °C) and 104 °F (40 °C) are considered safe for a healthy adult. Lower water temperatures are recommended for young children and when hot tub use exceeds 10 minutes. Since excessive water temperatures have a high potential for causing fetal damage during the early months of pregnancy, pregnant or possibly pregnant women should limit hot tub water temperatures to 100 °F (38 °C). If pregnant, please consult your physician before using a hot tub. Before entering the hot tub, the user should measure the water temperature with an accurate thermometer since the tolerance of water temperature regulating devices may vary as much as +/- 5 °F (2 °C). Persons suffering from obesity or a medical history of heart disease, low or high blood pressure, circulatory system problems or diabetes should consult a physician before using a hot tub.

**CAUTION:** Risk of Hyperthermia: Hyperthermia occurs when the internal temperature of the body reaches a level several degrees above the

normal body temperature of 98.6 °F (37 °C). The symptoms of hyperthermia include drowsiness, lethargy, and an increase in the internal temperature of the body. Prolonged immersion in hot water may induce hyperthermia. A description of the causes, symptoms, and effects of hyperthermia are as follows:

- Unawareness of impending hazard;
- Failure to perceive heat;
- Failure to recognize the need to exit hot tub;
- Physical inability to exit hot tub;
- Fetal damage in pregnant women; and
- Unconsciousness and danger of drowning.

**WARNING:** Children should not use hot tubs without adult supervision.  
**WARNING:** Do not use hot tubs unless all suction guards are installed to prevent body and hair entrapment.

**WARNING:** People with infectious diseases should not use a hot tub.

**WARNING:** To avoid injury, exercise care when entering or exiting the hot tub.

**WARNING:** Do not use drugs or alcohol before or during the use of a hot tub to avoid unconsciousness and possible drowning. The use of alcohol or drugs can greatly increase the risk of fatal hyperthermia in hot tubs.

**WARNING:** Pregnant or possibly pregnant women should consult a physician before using a hot tub.

**WARNING:** Water temperature in excess of 38 °C (100 °F) may be injurious to your health. Before entering the hot tub, measure the water temperature with an accurate thermometer.

**WARNING:** Do not use a hot tub immediately following strenuous exercise.

**WARNING:** Prolonged immersion in a hot tub may be injurious to your health.

**WARNING:** Do not permit electric appliances (such as lights, telephone, radio, television, etc.) within 5 feet (1.5m) of this hot tub unless such appliances are built-in by the manufacturer.

**WARNING:** People using medication and/or having an adverse medical history should consult a physician before using a spa or hot tub.

**CAUTION:** Observe a reasonable time limit when using the hot tub. Long exposures at higher temperatures can cause high body temperature. Symptoms may include dizziness, nausea, fainting, drowsiness, and reduced awareness. These effects could possibly result in drowning.

**CAUTION:** Enter and exit the hot tub slowly. Wet surfaces can be very slippery.

**CAUTION:** Proper chemical maintenance of hot tub water is necessary to maintain safe water and prevent possible damage to hot tub components. Maintain water chemistry in accordance with manufacturer's instructions.

**CAUTION:** Use the straps and clip tie downs to secure the cover when not in use. This will help to discourage unsupervised children from entering the hot tub and keep the hot tub cover secure in high-wind conditions. There is no representation that the cover, clip tie-downs, or actual locks will prevent access to the hot tub.

**CAUTION:** For exercise, the water should not exceed 90 °F (32 °C).

**CAUTION:** When using this electrical equipment, basic safety precautions should always be followed.

**PREPARATION AND SET-UP FOR YOUR NEW SPA  
LOCATION FOR YOUR NEW SPA:**

- You want to keep in mind how you intend to use the spa and plan the location accordingly.
- How close is the spa from the exit or entrance to your house? (consider the cold weather)
- Is the path to your spa clean of debris, sand, grass? (so as not to track into the spa)
- Is there protection from wind, inclement weather?
- Can neighbors or passersby see the spa?

**NOTE: Allow for service access:** Many spa owners enjoy placing their spa in a decorative enclosure or a deck. Keep in mind that you need to have access to the equipment for maintenance and the spa should be able to be moved or lifted without destroying the special enclosure or its surroundings. You should discuss this with your dealer when designing the location. Extension cords are not to be used in conjunction with the operations of the spa. Low voltage damage could result and this is not covered by warranty. **NOTE:** All components must be 120V; No 240V components allowable.

**240VAC:** Depending on the model of spa, it will require either a 40 Amp, 50 Amp, or 60 Amp dedicated circuit breaker, GFCI, with the proper wire size based on the length of the run. The electrical circuit must be installed by a certified electrician and approved by a local building or electrical inspector.

**ELECTRICAL REQUIREMENTS**

All self contained spas use 120VAC or 240VAC electrical spa packs.. These instructions describe the only acceptable electrical wiring procedures. Spas wired in any other way will void your warranty and may result in serious injury. All installations should be completed by a certified electrician. Failure to comply with state and local codes may result in fire or personal injury and will be the sole responsibility of the spa owner.

**120VAC:** This requires an isolated 20 Amp circuit breaker. This needs to be an isolated circuit with no other appliances or lights on this circuit at any time. Extension cords are not to be used in conjunction with the operations of the spa. Low voltage damage could result and this is not covered by warranty. **NOTE:** All components must be 120V; No 240V components allowable.

**240VAC:** Depending on the model of spa, it will require either a 40 Amp, 50 Amp, or 60 Amp dedicated circuit breaker, GFCI, with the proper wire size based on the length of the run. The electrical circuit must be installed by a certified electrician and approved by a local building or electrical inspector.

**SURFACE AND PAD REQUIREMENTS**

Your new portable spa must be placed on a firm, flat and level surface, so the spa weight is supported uniformly. We recommend no less than a 3" (93 mm) thick concrete slab. Wood decking or balconies must be constructed to support 150 pounds per square foot (730 kg/m<sup>2</sup>). Refer to local and current building codes in your area. Consult an engineer for live loads in your area. Should your new spa need to go through a gate, the opening should be a minimum of 48 inches and up to 8.5' overhead clearance depending on the size of the unit.

**NOTE:** Damage caused by alternate decking methods may void the spa warranty. Contact your local dealer if you have any questions regarding spa location or placement.

**DRAINING AND WINTERIZING**

**DRAINING YOUR SPA**

After a period of 3-4 months, detergent residues from bathing suits and soap film will build up in your spa water. Once this happens, your spa water will appear cloudy and should probably be replaced.

- Turn power OFF at the breaker.
- Locate the drain valve (usually in the equipment area).
- Remove the safety cap and attach garden hose.
- Drain water to a convenient area. (Spa water may harm grass or plants if sanitizer levels are high.)
- When water begins to flow out of the hose, open the air relief valve located on filter lid (Hydro-Cyclonic Filtration) or Air Bleeder Valve (Skim Filtration)
- Your spa will drain except for a small portion left in the foot well. This can be removed with a sponge and pail.
- Once empty, clean as required.
- To finish, remove garden hose and attach safety cap.

**IMPORTANT (Cascade Series Only):** There will be an additional drain valve. This is connected directly to the tank reservoir and you will see the water level go down on the sight tube in the equipment area.

**WINTERIZING YOUR SPA**

In many areas of the world the temperature may drop below 32°F (0°C). We recommend the spa is always filled with water and running at normal spa temperatures. By doing this you will minimize the risk of freezing within your spa. If it is necessary to leave your spa unattended for long periods of time during cold weather conditions, you should drain your spa to avoid accidental freezing caused by power outages. Your local dealer can perform the following winterizing procedures, if you are not completely comfortable with them.

- Ensure that you have fully drained the spa (Refer to the DRAINING YOUR SPA section)
- After draining, your spa may still have water remaining in the equipment and plumbing fittings. Disconnect the hand-tightened union fittings going to and from the jet pumps. Be careful not to lose the o-rings between the unions and pump housing.
- Leave drain valve in the open position and safety cap off .
- To completely drain the plumbing lines, a wet/dry shop vacuum can be used to draw out any remaining water. Place the vacuum hose over the jet fittings in the

spa as well as the plumbing lines in the equipment area. You should also disconnect the plug on the crystal clear inspection tube (if installed)

- Remove the filter cartridge and store in a warm, dry area.
- Clean the spa shell and place spa cover on spa. Be sure to lock the cover in place in case of high winds or rain.

**WARNING:** The instructions above should be followed accordingly when winterizing your spa however they are guidelines and potential freeze damage may still occur. All freeze damage is the sole responsibility of the spa owner and will not be covered by the warranty should it occur.

**EMERGENCY SITUATIONS:** To eliminate freezing in the event of equipment failure, use a 100-watt light bulb or small heater via extension cord and place it in the equipment area, keeping it away from plumbing lines. This will help for a short period of time until proper service can be rendered.

**FILTER MAINTENANCE**

The spa filter is one of the most important maintenance items of a hot tub. The filter is there to remove debris from the water and needs to be cleaned on a regular basis. Failure to do so may result in poor performance, poor water clarity and could prevent the spa from heating. Filtration starts as soon as flow is steady through the filter. As the filter cartridge removes the debris from the spa water, the accumulated debris causes flow resistance.

**CLEANING AND REPLACING FILTER CARTRIDGE**

Your spa filter has been designed for quick and easy maintenance. The filter cartridge should be rinsed by hose once a week and cleaned with a cartridge cleaner once a month. A second filter cartridge is recommended and will speed up this process. This can be purchased from your local dealer.

**TOP LOAD FILTERS**

- Turn power OFF at the breaker.
- Loosen air relief valve, then remove retainer ring.
- Pull filter lid straight up to remove.
- Do not twist or pull the filter lid up on an angle. This could cause damage to the filter canister, especially in freezing conditions.
- Remove filter cartridge and clean with a garden hose and a high-pressure nozzle. Periodically you may need to soak your filter in a "cartridge filter cleaner" to remove excess minerals and/or oils.
- Rinse filter thoroughly before installing. Clean o-ring on filter lid and apply a light film of silicone lubricant to the o-ring. Do not use a petroleum-based lubricant as it could damage the o-ring. Consult your dealer to purchase suitable lubricant.
- Place clean Cartridge in filter canister.
- Replace filter lid and re-tighten retaining ring (finger tight only)



**NOTE:** Make sure the o-ring is on the air relief valve, and is finger tight prior to starting the pump. This o-ring should periodically be lubricated with a silicone lubricant.

- There is a 3/8" clear line coming from the filter area and this goes to the bottom corner of the spa. This drains all the water from around the filter canister.
- This is a good time to check the skimmer basket. Bring skimmer door (weir) forward and unscrew basket. Clean out debris and reinstall.

**Look for these specialized cleaning attachments at your local dealership.**



**WATER QUALITY MAINTENANCE**

Maintaining the quality of the water within the specified limits will serve to enhance your enjoyment and prolong the life of the hot tub's equipment. It is a fairly simple task, but it requires regular attention because the water chemistry involved is a balance of several factors. There is no simple formula, and there is no avoiding it. An indifferent approach to water maintenance will result in poor and potentially harmful conditions for soaking and even damage to your hot tub investment. The most important thing to keep in mind is that *preventing* poor water chemistry is much easier than *correcting* poor water chemistry. For specific guidance on maintaining water quality, consult your Authorized Dealer who can recommend appropriate chemical products for sanitizing and maintaining your hot tub.

**MAINTAIN HEALTHY SPA WATER**

**Important!** When maintaining your hot tub's water chemistry, ensure that your cover is removed during any aggressive treatments to allow for dissipation into the air. Take care to remove the cover slowly and let chemicals deplete if you are uncertain if your water is properly balanced. **Always maintain your hot tub's water chemistry within the following parameters:**

**pH:** pH is a measure of relative acidity or alkalinity of water and is measured on a scale of 0 to 14. The midpoint of 7 is said to be neutral, above which is alkaline and below which is acidic. In hot tub water, it is very important to maintain a slightly alkaline condition of 7.2 to 7.8. Problems become proportionately severe the further outside of this range the water

gets. A low pH will be corrosive to metals in the hot tub equipment. A high pH will cause minerals to deposit on the interior surface (scaling). In addition, the ability of the sanitation agents to keep the hot tub clean is severely affected as the pH moves beyond the ideal range. That is why almost all hot tub water test kits contain a measure for pH as well as sanitizer.

**Sanitizer (Chlorine or Bromine):** To destroy bacteria and organic compounds in the hot tub water by breaking them down into non-harmful levels which get filtered out. A sanitizer must be used regularly, either chlorine or bromine. Sanitizing your spa water is the most important spa maintenance you can do for yourself.

**Total Alkalinity:** This refers to the ability of the hot tub water to resist changes in pH. Controlling alkalinity can help keep your pH in the appropriate range thereby lessening the need for pH balancing. If the TA is too low the pH level will fluctuate rapidly from high to low. If the TA is too high the pH will tend to be too high and will be very difficult to bring back down.

**Calcium Hardness:** This is a measurement of dissolved calcium in the water. Calcium will help control the corrosive nature of the spa's water.

**WARNING:** Never store chemicals inside the equipment area of your spa.

**IMPORTANT:** Do not use Hydrogen Peroxide based sanitizers in your spa. When using Chlorine or Bromine tablets you must use a floating dispenser. These chemicals can have an extremely corrosive effect on certain materials in the spa. Damage caused by use of these chemicals, or improper use of any chemicals, is not covered under the spa's warranty.

**OTHER ADDITIVES:** Many other additives are available for your spa. Some are necessary to compensate for out-of-balance water, some aid in cosmetic water treatment and others simply alter the feel or smell of the water. Your Authorized Dealer can advise you on the use of these additives.



**WATER CLARITY TROUBLESHOOTING**

PROBLEM	PROBABLE CAUSE	POTENTIAL SOLUTIONS
<b>Water Odor</b>	<ul style="list-style-type: none"> <li>• Improper sanitization</li> <li>• Excessive organics in water</li> <li>• pH is too low</li> </ul>	<ul style="list-style-type: none"> <li>&gt; Add sanitizer</li> <li>&gt; Shock spa with sanitizer</li> <li>&gt; Adjust pH</li> </ul>
<b>Chlorine Odor</b>	<ul style="list-style-type: none"> <li>• Chloramines are too high</li> <li>• pH is too low</li> </ul>	<ul style="list-style-type: none"> <li>&gt; Shock spa with sanitizer</li> <li>&gt; Adjust pH</li> </ul>
<b>Musty Odor</b>	<ul style="list-style-type: none"> <li>• Bacteria or Algae growth</li> </ul>	<ul style="list-style-type: none"> <li>&gt; Shock spa with sanitizer</li> <li>&gt; Drain and refill spa water</li> </ul>
<b>Scale</b>	<ul style="list-style-type: none"> <li>• Total alkalinity is too high</li> <li>• pH is too high</li> <li>• High calcium content in water</li> </ul>	<ul style="list-style-type: none"> <li>&gt; Adjust total alkalinity</li> <li>&gt; Adjust pH</li> <li>&gt; Use stain and scale product</li> </ul>
<b>Stains</b>	<ul style="list-style-type: none"> <li>• Total alkalinity is too low</li> <li>• pH is too low</li> <li>• High metal content in water</li> </ul>	<ul style="list-style-type: none"> <li>&gt; Adjust alkalinity</li> <li>&gt; Adjust pH</li> <li>&gt; Use stain and scale product</li> </ul>
<b>Cloudy Water</b>	<ul style="list-style-type: none"> <li>• Poor filtration</li> <li>• pH is too high</li> <li>• Hardness is too high</li> <li>• Total alkalinity is too high</li> <li>• Suspended particles</li> </ul>	<ul style="list-style-type: none"> <li>&gt; Clean filter cartridge</li> <li>&gt; Adjust pH</li> <li>&gt; Adjust hardness</li> <li>&gt; Adjust total alkalinity</li> <li>&gt; Drain and refill spa water</li> </ul>
<b>Algae Growth</b>	<ul style="list-style-type: none"> <li>• pH is too high</li> <li>• Sanitizer is too low</li> </ul>	<ul style="list-style-type: none"> <li>&gt; Adjust pH</li> <li>&gt; Shock spa with sanitizer</li> <li>&gt; Adjust sanitizer level</li> </ul>
<b>Eye Irritation</b>	<ul style="list-style-type: none"> <li>• pH is too low</li> <li>• Sanitizer is too low</li> </ul>	<ul style="list-style-type: none"> <li>&gt; Adjust pH</li> <li>&gt; Shock spa with sanitizer</li> <li>&gt; Adjust sanitizer level</li> </ul>
<b>Skin Rash/Irritation</b>	<ul style="list-style-type: none"> <li>• Free chlorine level too high</li> <li>• Unsanitary water</li> </ul>	<ul style="list-style-type: none"> <li>&gt; Adjust chlorine level</li> <li>&gt; Shock spa with sanitizer</li> <li>&gt; Adjust sanitizer level</li> </ul>

## PRODUCT & CARE GUIDE

Your Authorized Dealer carries a wide variety of care and maintenance products. For more information please contact your Dealer.

### REQUIRED FILTER MAINTENANCE

Your new hot tub is equipped with a filter cartridge. To ensure maximum water quality at all times, you should replace the filter cartridge every six months, or earlier as necessary. The filter cartridge is designed to be thrown away! Attempts to re-use the filter cartridge may result in the re-release of unwanted particles back into the hot tub.

### PLEATCO DUAL CORE FILTERS

Your hot tub/spa comes with a premium filter. Most come with equipped with a Pleatco DualCore Filter, which does a better job of cleaning your spa water than any other filter cartridge. The DualCore filter has two layers of filtration media, the outer layer and the inner layer. Both are engineered to remove different particles from your water.

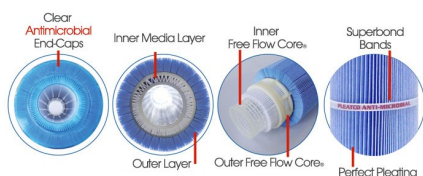

The outer core is similar to a traditional filter which traps larger debris, while the inner core filters the water for particles down to 3 microns in size. The inner core is easily removed and both filter media can be cleaned.

Keeping your spa water clean and refreshing is extremely important for your enjoyment of your hot tub. Our hot tubs come with only the best filters available in order to ensure your satisfaction.

### REQUIRED WATER REPLACEMENT

You should replace the hot tub's water every 3-6 months. The frequency will depend on a number of variables including frequency of use, number of bathers and attention paid to the water quality maintenance. You will know it is time for a change when you can no longer get the normal feel or sparkle to the water, even though the key water balance measurements are all within the recommended ranges.

### HEADREST / PILLOW CARE

The pillows can be removed for easy cleaning and maintenance. All pillows have plugs within the pillow itself. To remove the pillow, grab the bottom edge firmly and pull outward. This will allow the pillows to pop-out from the receptacle in the spa shell. To reinstall the pillow you will align the pillow plug with the receptacle. Press/hit the front side of the pillow firmly, which will insert the plug back into the receptacle.

- **Proper water chemistry must be maintained. Your hot tub pillows are easily and quickly damaged when exposed to unbalanced spa water.** If you suspect that your chemicals may be unbalanced, remove your pillows immediately until the water has been restored to suggested conditions.
- Do not sit on the pillows

- Do not pull on the pillows
- Pillows should be cleaned using a soft cloth and mild soap, then wiped with a conditioner. We recommend that pillows be washed each time you drain you spa.

### HOT TUB INTERIOR

Your hot tub has a fiberglass reinforced acrylic shell. Generally dirt and stains will not adhere to the surface. To properly clean the surface, we recommend wiping it with a soft damp cloth (or sponge) using household soap or liquid detergent and rinsing thoroughly with fresh water. Stubborn dirt or stains may be removed by using Spic & Span adequately dissolved in water. Contact your dealer and inquire about maintenance packages.

**DO NOT** use any cleaning products containing abrasives or solvents, since these could damage the surface. Harsh chemicals should never be used on acrylic surfaces. Damage to the shell due to the use of harsh chemicals is not covered under the warranty.

**DO NOT** leave your hot tub drained and in direct sunlight for extended periods of time. Extreme heat could cause damage to the acrylic surface and may induce an effect known as "crazing".

### STAINLESS STEEL CONTROLS AND COMPONENTS ABOVE THE WATER LINE

To preserve the stainless steel finish of the controls and components above the water line, we recommend they be wiped with a dry soft cloth after each use of your hot tub. In addition, off-gas your tub by removing the cover for approximately 30 minutes multiple times per week (if not in use) and after every shock treatment.

### CABINET CARE

Never spray cabinets with a high-pressure garden hose or pressure washer for any reason. This action may induce an electrical short in the hot tub's electrical equipment.

### CEDAR CABINET

Our cedar cabinets are made from top quality Western Cedar and manufactured and stained at our factory. With proper care and maintenance, your cedar cabinet should maintain its beauty for many years. Manufacturer recommends touch-up or re-staining of the cabinet every three to four years depending on your environment. Contact your Dealer for re-staining procedures.

### VINYL CABINET

Vinyl cabinets are made of a rigid polymer that combines the durability of plastic with the beauty of real wood. This cabinet is manufactured so that it won't crack, peel, blister or delaminate even after prolonged exposure to the elements. We recommend wiping the cabinet with a soft damp cloth (or sponge) using household soap or liquid detergent and rinsing with fresh water thoroughly. **DO NOT** use abrasive cleansers or material as this may damage the surface.

**SLATE CABINETS**

Optional Slate cabinets are custom-built and painted in our factory. We recommend lightly brushing the cabinet with a SOFT bristle brush to remove any dirt or stains. For more information on the care of your Slate cabinet, please contact your Local Dealer.

**COVER CARE**

A well cared for spa cover is a thing of beauty in its own right. Be sure to clean and condition your cover at least once a month – more often if needed. Your cover needs to be cleaned and conditioned because vinyl can be dry and become brittle, spoiling your spa's appearance. Dry, brittle vinyl can also tear at the seams and stress points. Quality materials, internal sewn reinforcing and careful workmanship can only go so far against the ravages of Mother Nature. See the specific Warranty card enclosed with your cover for further details.

- When you shock your spa you need to remove the cover for a minimum of 30 minutes to ensure that the chemical gas off can escape from the spa.
- You are required to keep the spa covered at all time when not in use to protect the shell from harmful UV rays.
- A covered spa will use less electricity when maintaining the desired water temperature
- See the manual that comes with the cover for proper mounting of the cover locks
- The cover should remain locked at all times to prevent unauthorized entry into the spa and potential drowning.
- Do not Sit, Stand or Lie on your cover. Nor should you place any heavy object on top of the cover as this may damage the structure.

**VERY IMPORTANT:** We recommend a vinyl conditioner for your spa cover. Your local dealer carries a wide variety of care and maintenance products. Choose a pleasant day each month to remove your cover from the spa and lay it on a flat surface accessible by garden hose. Douse the cover with a healthy amount of water from the hose or a bucket to rinse away loose dirt or debris. Using a soft bristle brush and a mild solution of dishwashing liquid (about one teaspoon of detergent to two gallons of water), and with a gentle circular motion, scrub the cover clean. Be careful not to let any areas of the cover dry before they're thoroughly rinsed. Now apply the vinyl conditioner as directed on the container. Massage the conditioner into the cover in a gentle but firm manner. Before replacing the cover on your spa, wipe and rinse any dirt from the bottom of the cover. When you are ready, put the cover on the spa.

**NOTE:** To remove tree sap, use lighter fluid (not charcoal lighter but the fluid used in cigarette lighters). Use sparingly, then immediately apply conditioner to that area.

**GLOSSARY OF TERMS**

**AIR CONTROL VALVE:** Mounted generally on the lip of the spa, it induces warm air from the equipment enclosure into the jet stream through venturi action.

**WATER DIVERTER VALVE:** The large diverter is used to divert water to various seats in the spa.

**ON/OFF DIVERTER VALVE:** The smaller diverter is used to control water flow and to turn on/off the neck jets and/or waterfalls.

**FILTER AIR RELIEF VALVE:** Located on top of dome filter lid. Used to release air from the filter.

**SKIMMER BLEEDER VALVE:** Located in the skimmer area, needs to be loosened while filling the spa. This will help eliminate air from being trapped in the spa equipment.

**OZONATOR:** Available as an option. The ozonator produces natural ozone through the Corona Discharge process. Continuous use of an ozonator can dramatically reduce sanitizer consumption.

**CONTROL BOX (Pack):** Basically the "heart" of the spa. Power is distributed to any/all functions of the spa: pumps, ozonator, LED lighting, heater element, etc.

**CONTROL PANEL:** Mounted on the top lip of the spa and controls the functions of the spa.

**DRAIN VALVE:** Used in draining of the spa. Normally located in the equipment area.

**EQUIPMENT ENCLOSURE:** An enclosure that houses the control box, pump(s) and other electrical components.

**FILTER:** The filter cleans the spa by passing water through a filter cartridge where debris and impurities are removed. Top load filter means the filter cartridge is accessible through the top of the spa. Front access skimmer means cartridge is accessed through door of skimmer.

**FLOOR DRAIN:** The floor drain is covered by a grate-type cover and is utilized when draining the spa. It also acts as the return for the ozonator. You will see bubbles emitted from this drain, which is the result of water mixing with the ozone output.

**GATE VALVES:** Red with a grey handle is located at the inlet and outlet of the pumping system. Used while servicing the spa equipment, the valves open or close the water flow to the equipment. To remain open for normal use, turn fully counterclockwise.

**KNIFE VALVES:** A white "T"-handled valve, same functions as Gate valve (see above), except to open them you pull up on handle.

**HEATER:** The electronically controlled heater raises the temperature of the spa to the desired setting.

**LEDs:** LEDs and their special lenses can be used to achieve the desired mood lighting in the spa and spa jets.

**SKIMMER:** This is the rectangular outlet at the water level. The skimmer removes surface debris to the filter. The water level in the spa should be kept ½ to ¾ up on the skimmer for optimum operation.

**SUCTION FITTING:** During operation of the equipment, the suction works in conjunction with the skimmer to draw water from the bottom of the spa through the filter, keeping the spa sparkling clean.

**NECK JET:** Direction-controllable jet for soothing neck massage.

**ADJUSTABLE CLUSTER JET:** Our adjustable, high-intensity hydrotherapy jet.

**DIRECTIONAL JET:** Provides a straight flow for a therapeutic massage

**ROTATIONAL JET:** Provides a Uni-directional circular therapeutic massage.

**MESSAGE JET:** Delivers massage in staccato bursts over a narrow, focused area.

**VOLCANO/WHIRLPOOL JET:** high-output jet designed for foot and leg massage.

**LAMINAR FLOW WATER FEATURE:** A thin stream of water that arcs from the spa lip

## BASIC INSTALLATION AND CONFIGURATION GUIDELINES

### Warning! Qualified Technician Required for Service and Installation

Use minimum 6AWG copper conductors only. Torque field connections between 21 and 23 in lbs. Readily accessible disconnecting means to be provided at time of installation. Permanently connected power supply. Connect only to a circuit protected by a Class A Ground Fault Circuit Interrupter (GFCI) or Residual Current Device (RCD) mounted at least 5' (1.52M) from the inside walls of the spa/hot tub and in line of sight from the equipment compartment.

### CSA ENCLOSURE: TYPE 2

Refer to Wiring Diagram inside the cover of the control enclosure. Refer to Installation and Safety Instructions provided by the spa manufacturer.

**Warning:** People with infectious diseases should not use a spa or hot tub.

**Warning:** To avoid injury, exercise care when entering or exiting the spa or hot tub.

**Warning:** Do not use a spa or hot tub immediately following strenuous exercise.

**Warning:** Prolonged immersion in a spa or hot tub may be injurious to your health.

**Warning:** Maintain water chemistry in accordance with the Manufacturers instructions.

**Warning:** The equipment and controls shall be located no less than 1.5 meters horizontally from the spa or hot tub.

### WARNING! GFCI OR RCD PROTECTION.

The Owner should test and reset the GFCI or RCD on a regular basis to verify its function.

### WARNING! SHOCK HAZARD! NO USER SERVICEABLE PARTS.

Do not attempt service of this control system. Contact your dealer or service organization for assistance. Follow all owner's manual power connection instructions. Installation must be performed by a licensed electrician and all grounding connections must be properly installed.

- Disconnect the electric power before servicing. Keep access door closed.

### CSA COMPLIANCE

#### Caution:

- Test the ground fault circuit interrupter before each use of the spa.
- Read the instruction manual.
- Adequate drainage must be provided if the equipment is to be installed in a pit.
- For use only within an enclosure rated CSA Enclosure 3.
- Connect only to a circuit protected by a Class A ground fault circuit interrupter or residual current device.
- To ensure continued protection against shock hazard, use only identical replacement parts when servicing.
- Install a suitably rated suction guard to match the maximum flow rate marked.

#### Warning:

- Water temperature in excess of 38°C may be injurious to your health.
- Disconnect the electrical power before servicing.

**TROUBLESHOOTING GUIDE**

**SPA SYSTEM**

SYMPTOM	PROBABLE CAUSE	RECOMMENDED ACTION
<b>Spa does not work</b>	<ul style="list-style-type: none"> <li>• Power is turned off</li> </ul>	<ul style="list-style-type: none"> <li>&gt; Reset GFCI</li> </ul>
<b>No display on the control panel</b>	<ul style="list-style-type: none"> <li>• Power is turned off</li> <li>• Defective topside control</li> </ul>	<ul style="list-style-type: none"> <li>&gt; Reset GFCI</li> <li>&gt; Contact your Dealer</li> </ul>
<b>Letters on the control panel</b>	<ul style="list-style-type: none"> <li>• An error has been found</li> </ul>	<ul style="list-style-type: none"> <li>&gt; Refer to the Reference Card for your control panel to verify the error. Contact your Dealer for service</li> </ul>

**PUMP PROBLEMS**

SYMPTOM	PROBABLE CAUSE	RECOMMENDED ACTION
<b>Noisy/Loud motor</b>	<ul style="list-style-type: none"> <li>• Air trapped in the pump</li> <li>• Low water level</li> <li>• Worn pump seal</li> <li>• Defective pump</li> </ul>	<ul style="list-style-type: none"> <li>&gt; Open bleed valve in the skimmer</li> <li>&gt; Add water to the spa</li> <li>&gt; Contact your Dealer</li> <li>&gt; Contact your Dealer</li> </ul>
<b>Pumps power down on their own</b>	<ul style="list-style-type: none"> <li>• Set temperature has been reached</li> <li>• Filtration cycle has ended</li> <li>• Automatic time out</li> <li>• Overheat safety protection</li> </ul>	<ul style="list-style-type: none"> <li>&gt; No problem</li> <li>&gt; No problem</li> <li>&gt; Pumps are set to run for a predetermined time while the spa is in use (15-20 Mins)</li> <li>&gt; The pumps have a thermal overload which will prevent them from running for extended periods of time. Wait until pumps have cooled down (1+ hrs). If problem persists, contact your Dealer.</li> </ul>
<b>Pump running constantly, will not turn off</b>	<ul style="list-style-type: none"> <li>• Filter cycle set to 24 hours</li> <li>• Problem with the circuit board</li> </ul>	<ul style="list-style-type: none"> <li>&gt; Turn off 24 hour filtration</li> <li>&gt; Turn power off at GFCI and contact your Dealer</li> </ul>
<b>Pump will not turn on</b>	<ul style="list-style-type: none"> <li>• GFCI tripped</li> <li>• Motor has overheated</li> <li>• Not plugged in</li> <li>• Damaged plug</li> <li>• Seized motor</li> <li>• Blown fuse</li> <li>• Motor vent is blocked</li> </ul>	<ul style="list-style-type: none"> <li>&gt; Reset the GFCI</li> <li>&gt; Let cool for 1+ hour</li> <li>&gt; Plug in to the board</li> <li>&gt; Contact your Dealer</li> <li>&gt; Contact your Dealer</li> <li>&gt; Check fuse or contact your Dealer</li> <li>&gt; Clear debris from the vent</li> </ul>

<b>HEAT PROBLEMS</b>	<b>PROBABLE CAUSE</b>	<b>RECOMMENDED ACTION</b>
<b>Water will not heat</b>	<ul style="list-style-type: none"> <li>• Error message on control panel</li> <li>• Spa is in a different Heat Mode</li> <li>• Water level is too low</li> <li>• Poor water flow</li> <li>• Closed valves</li> <li>• Pump 1 is not running</li> </ul>	<ul style="list-style-type: none"> <li>&gt; Refer to the Reference Card for your control panel to verify the error</li> <li>&gt; Set spa to "Standard Mode"</li> <li>&gt; Add water to the spa</li> <li>&gt; Clean filter &amp; check valves</li> <li>&gt; Open all valves</li> <li>&gt; Contact your dealer</li> </ul>
<b>Water is too hot</b>	<ul style="list-style-type: none"> <li>• Incorrect reading</li> <li>• Filter cycle duration is too long</li> <li>• Pump speeds reversed</li> </ul>	<ul style="list-style-type: none"> <li>&gt; Verify temperature with thermometer</li> <li>&gt; Reduce duration of the filter cycle</li> <li>&gt; Contact your dealer</li> </ul>
<b>Water will not maintain heat</b>	<ul style="list-style-type: none"> <li>• Cover is off for extended periods of time in cold weather / cold wind.</li> <li>• Hot tub is wired for 110V and jets are on.</li> </ul>	<ul style="list-style-type: none"> <li>&gt; Put cover back onto hot tub and allow for heat to regenerate. Call your dealer if temperature does not increase.</li> <li>&gt; Hot tubs wired for 110V only have enough power to heat or operate pumps. Turn off jets to power heater.</li> </ul>

<b>LIGHTING ISSUES</b>	<b>PROBABLE CAUSE</b>	<b>RECOMMENDED ACTION</b>
<b>Standard light will not come on</b>	<ul style="list-style-type: none"> <li>• Bulb has burnt out</li> </ul>	<ul style="list-style-type: none"> <li>&gt; Replace the light bulb</li> </ul>
<b>LED lighting not in sync</b>	<ul style="list-style-type: none"> <li>• Burnt out bulb/connection</li> </ul>	<ul style="list-style-type: none"> <li>&gt; Contact your dealer</li> </ul>
<b>LED lighting won't come on</b>	<ul style="list-style-type: none"> <li>• Incorrect settings</li> </ul>	<ul style="list-style-type: none"> <li>&gt; Contact your dealer</li> </ul>

<b>PUMPS WILL NOT PRIME</b>	<b>PROBABLE CAUSE</b>	<b>RECOMMENDED ACTION</b>
<b>Pump on but no water flow</b>	<ul style="list-style-type: none"> <li>• Air trapped in pump</li> <li>• No water in the pump</li> <li>• Closed valves</li> </ul>	<ul style="list-style-type: none"> <li>&gt; Loosen bleed valve in skimmer</li> <li>&gt; Check the fill level in the spa</li> <li>&gt; Open all valves</li> </ul>

<b>HYDROTHERAPY JETS</b>	<b>PROBABLE CAUSE</b>	<b>RECOMMENDED ACTION</b>
<b>Little to no water flowing from jets</b>	<ul style="list-style-type: none"> <li>• Jets turned off</li> <li>• Pump not primed</li> <li>• Valves are closed</li> <li>• Diverter set to a different seat</li> <li>• Dirty filter</li> </ul>	<ul style="list-style-type: none"> <li>&gt; Open jet by turning the face counter clockwise</li> <li>&gt; Reset breaker to allow for the spa to prime the pump. Open bleed valve in the skimmer area</li> <li>&gt; Open valves</li> <li>&gt; Switch diverter</li> <li>&gt; Remove and clean filter cartridge</li> </ul>

<b>PLUMBING SYSTEM</b>	<b>PROBABLE CAUSE</b>	<b>RECOMMENDED ACTION</b>
<b>Water around base of spa</b>	<ul style="list-style-type: none"> <li>• Loose connections</li> <li>• Leak from internal fitting</li> </ul>	<ul style="list-style-type: none"> <li>&gt; Hand tighten all quick disconnects and fittings.</li> <li>&gt; Check gaskets and o-rings</li> <li>&gt; Contact your dealer</li> </ul>



## LUXURY SERIES SPA CONTROLS

### THE MAIN SCREEN - SPA STATUS

Important information about spa operation can be seen on the Main Screen. Most features, including Set Temperature adjustment, can be accessed from this screen. The actual water temperature and Set Temperature can be seen, and the Set Temperature can be adjusted. Time-of-Day, Ozone and Filter status is available, along with other messages and alerts. The selected Temperature Range is indicated in the upper right corner. The Jets Icon in the center will spin if any pump is running and changes color when the heater is on. A Lock icon is visible if the panel or settings are locked. The Menu choices on the right can be selected and the screen will change to show more detailed controls or programming functions.

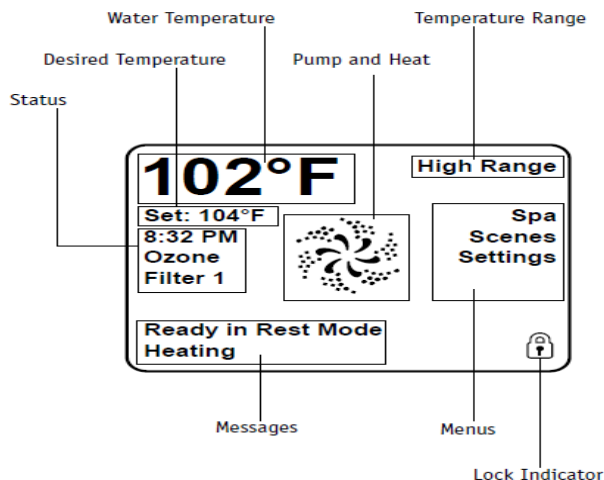

### NAVIGATION

Navigating the entire menu structure is done by touching the screen. When a text item is shown in white on the main screen, it is selectable. The menu selections on the right side of the screen can be selected. Select one of these to enter a different screen with additional controls. Most menu screens time out and revert to the main screen after 30 seconds of no activity.

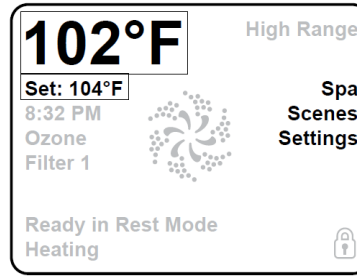

The only item that can be changed on the left side of the Main Screen is the Set Temperature. Touch either the set temperature line or the water temperature to go to the Set Temperature screen.

### MESSAGES

At the bottom of the screen, messages may appear at various times. Some of these messages must be dismissed by the user.

### THE SET TEMPERATURE SCREEN

#### SET TEMPERATURE

Press Inc or Dec to modify the Set Temperature. The Set Temperature changes immediately. Press Back to return to the Main Screen. If you need to switch between high range and low range you need to go to the Settings Screen.

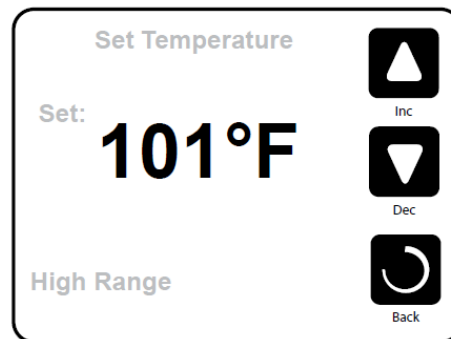

#### PRESS-AND-HOLD

If the Up or Down button is pressed and held, the temperature will continue to change until the button is released, or the Temperature Range limits are reached.

### THE SPA SCREEN

#### ALL EQUIPMENT ACCESS

The Spa Screen shows all available equipment to control, as well as other features, like Invert. The display shows icons that are related to the equipment installed on a particular spa model, so this screen may change depending on the installation. The icon buttons are used to select and control individual devices. Some devices, like pumps, may have more than one ON state, so the icon will change to reflect the state that

the equipment is in. Below are some examples of 2-speed Pump indicators.



If the Spa has a Circ Pump, a Circ Pump Icon will appear to indicate its activity, but outside of Priming Mode, the Circ Pump cannot be controlled directly.

NOTE: The icon for the pump that is associated with the heater (Circ or P1 Low) will have a red glow in the center when the heater is running.

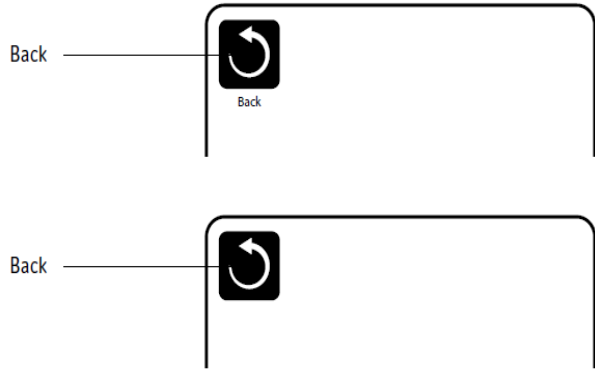
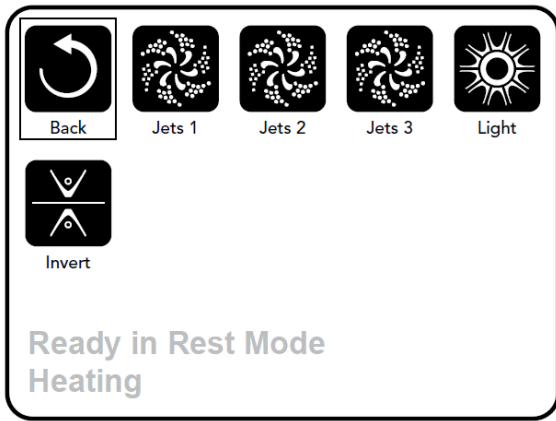

**PAGE UP/DOWN**

If an Up or Down button is shown and pressed when in a Menu List, the list can be scrolled a page at a time. The scroll bar on the right side of the screen indicates the relative position of the page.

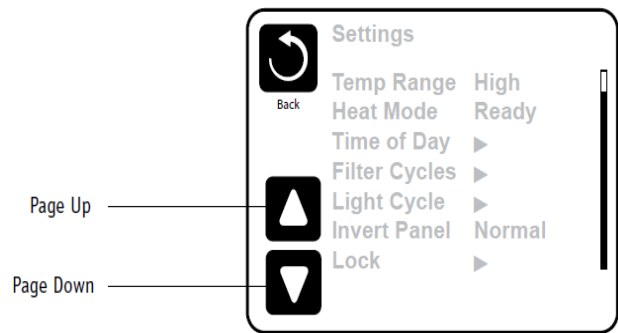

**COMMON BUTTONS**

**EXITING SCREENS**

When you see both of these buttons, whether they are labeled or not, they always mean Save and Cancel. They appear on most editing screens once you have changed the value on that screen.

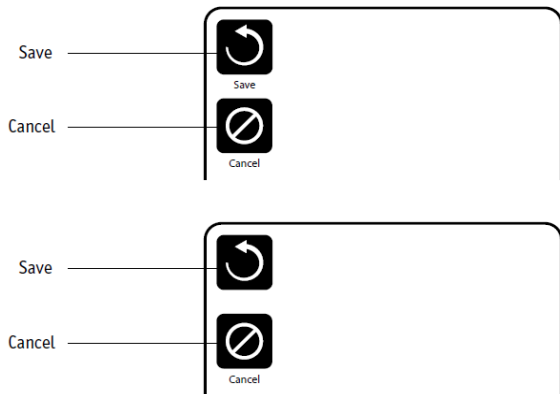

**VALUES INCREMENT/DECREMENT**

If an Up or Down button is shown and pressed when on an editing page, and a value has been selected (highlighted), the value can be incremented by pressing the up arrow or decremented by pressing the down arrow.

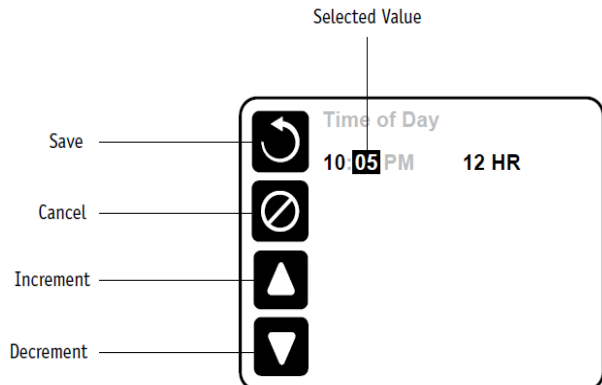

If the screen times out due to no activity it will act like Cancel. When you see only this button, whether it is labeled or not, it means Back or Exit. It appears on editing screens before you have changed any value, as well as on all other screens.



**THE SETTINGS SCREEN**

**PROGRAMMING, ETC.**

The Settings Screen is where all programming and other spa behaviors are controlled. This screen has several features that can be acted on directly. These features may include Temp Range, Heat Mode, Hold, and Invert Panel. When one of these items is selected, it will toggle between two settings. All other menu items (with an arrow pointing to the right) go to another level in the menu.

**DUAL TEMPERATURE RANGES (HIGH VS. LOW)**

This system incorporates two temperature range settings with independent set temperatures. The specific range can be selected on the Settings screen and is visible on the Main Screen in the upper right corner of the display. These ranges can be used for various reasons, with a common use being a "ready to use" setting vs. a "vacation" setting. Each range maintains its own set temperature as programmed by the user. This way, when a range is chosen, the spa will heat to the set temperature associated with that range.

- High Range can be set between 80°F and 104°F.
- Low Range can be set between 50°F and 99°F.

More specific Temp Ranges may be determined by the Manufacturer. Freeze Protection is active in either range.

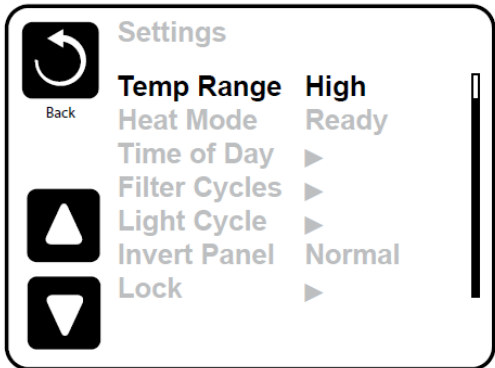

**HEAT MODE – READY VS. REST**

In order for the spa to heat, a pump needs to circulate water through the heater. The pump that performs this function is known as the "heater pump." The heater pump can be either a 2-speed pump (Pump 1) or a circulation pump. If the heater pump is a 2-Speed Pump 1, Ready Mode will circulate water every 1/2 hour, using Pump 1 Low, in order to maintain a constant water temperature, heat as needed, and refresh the temperature display. This is known as "polling." Rest Mode will only allow heating during programmed filter cycles. Since polling does not occur, the temperature display may not show a current temperature until the heater pump has been running for a minute or two. When the heater pump has come on automatically (for example for heating) you can switch between low speed and high speed but you cannot turn the heater pump off.

**CIRCULATION MODE**

If the spa is configured for 24HR circulation, the heater pump generally runs continuously. Since the heater pump is always running, the spa will maintain set temperature and heat as needed in Ready Mode, without polling. In Rest Mode, the spa will only heat to set temperature during programmed filter times, even though the water is being filtered constantly when in 24HR circulation mode.

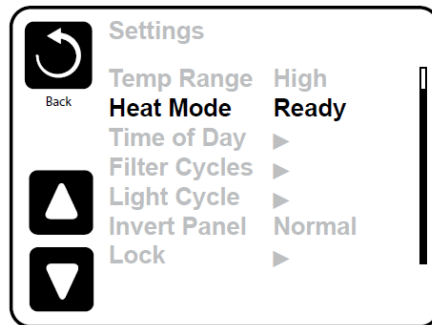

**READY-IN-REST MODE**

Ready in Rest Mode appears in the display if the spa is in Rest Mode and the Jets 1 Button is pressed. When the heater pump has come on automatically (for example for heating) you can switch between low speed and high speed but you cannot turn the heater pump off. After 1 hour, the System will revert to Rest Mode. This mode can also be reset by entering the Settings Menu and selecting the Heat Mode line.

**FILL IT UP!**

**PREPARATION AND FILLING**

Fill the spa to its correct operating level. Be sure to open all valves and jets in the plumbing system before filling to allow as much air as possible to escape from the plumbing and the control system during the filling process. After turning the power on at the main power panel, the top-side panel will display a splash screen or startup screen.

**PRIMING MODE – M019\***

After the initial start-up sequence, the control will enter Priming Mode and display a Priming Mode screen. Only pump icons appear on the priming mode screen. During the priming mode, the heater is disabled to allow the priming process to be completed without the possibility of energizing the heater under low-flow or no-flow conditions. Nothing comes on automatically, but the pump(s) can be energized by selecting the "Jet" buttons. If the spa has a Circ Pump, it can be turned on and off by pressing the "Circ Pump" button during Priming Mode.

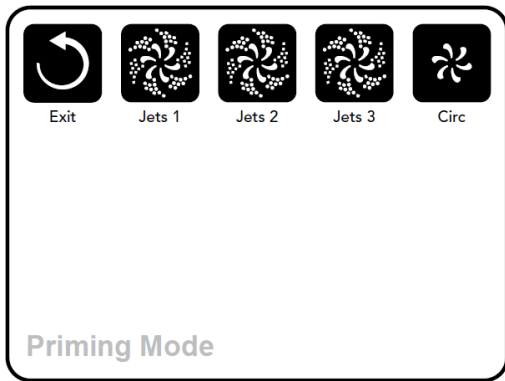

### PRIMING THE PUMPS

As soon as the Priming Mode screen appears on the panel, select the “Jets 1” button once to start Pump 1 in low-speed and then again to switch to high-speed. Also, select the other pumps, to turn them on. The pumps should be running in high-speed to facilitate priming. If the pumps have not primed after 2 minutes, and water is not flowing from the jets in the spa, do not allow the pumps to continue to run. Turn off the pumps and repeat the process. Note: Turning the power off and back on again will initiate a new pump priming session. Sometimes momentarily turning the pump off and on will help it to prime. Do not do this more than 5 times. If the pump(s) will not prime, shut off the power to the spa and call for service. Important: A pump should not be allowed to run without priming for more than 2 minutes. Under NO circumstances should a pump be allowed to run without priming beyond the end of the 4-5 minute priming mode. Doing so may cause damage to the pump and cause the system to energize the heater and go into an overheat condition.

### EXITING PRIMING MODE

The system will automatically enter the normal heating and filtering at the end of the priming mode, which lasts 4-5 minutes. You can manually exit Priming Mode by pressing the “Exit” button on the Priming Mode Screen. Note that if you do not manually exit the priming mode as described above, the priming mode will be automatically terminated after 4-5 minutes. Be sure that the pump(s) have been primed by this time. Once the system has exited Priming Mode, the top-side panel will display the Main Screen, but the display will not show the temperature yet, as shown below. This is because the system requires approximately 1 minute of water flowing through the heater to determine the water temperature and display it.

---°F      ---°C

## SPA BEHAVIOR

### PUMPS

On the Spa Screen, select a “Jets” button once to turn the pump on or off, and to shift between low- and high-speeds if equipped. If left running, the pump will turn off after a time-out period.

### NON-CIRC SYSTEMS

The low-speed of pump 1 runs when the blower or any other pump is on. If the spa is in Ready Mode, Pump 1 low may also activate for at least 1 minute every 30 minutes to detect the spa temperature (polling) and then to heat to the set temperature if needed. When the low-speed turns on automatically, it cannot be deactivated from the panel, however the high speed may be started.

### CIRCULATION PUMP MODES

If the system is equipped with a circ pump, it will be configured to work in one of three different ways:

1. The circ pump operates continuously (24 hours) with the exception of turning off for 30 minutes at a time when the water temperature reaches 3°F (1.5°C) above the set temperature (most likely to happen in very hot climates).
2. The circ pump stays on continuously, regardless of water temperature.
3. A programmable circ pump will come on when the system is checking temperature (polling), during filter cycles, during freeze conditions, or when another pump is on. The specific Circulation Mode that is used has been determined by the Manufacturer and cannot be changed in the field. Other device options may be available, like Blower, Light, Mister, etc.

### FILTRATION AND OZONE

On non-circ systems, Pump 1 low and the ozone generator will run during filtration. On circ systems, the ozone will generally run with the circ pump, but can be limited to filtration cycles. The system is factory-programmed with one filter cycle that will run in the evening (assuming the time-of-day is properly set) when energy rates are often lower. The filter time and duration are programmable. A second filter cycle can be enabled as needed. At the start of each filter cycle, the water devices like blower, mister device (if these exist) and other pumps will run briefly to purge the plumbing to maintain good water quality.

### FREEZE PROTECTION

If the temperature sensors within the heater detect a low enough temperature, then the water devices automatically activate to provide freeze protection. The water devices will run either continuously or periodically depending on conditions. In colder climates, an optional freeze sensor may be added to protect against freeze conditions that may not be sensed by the standard sensors. Auxiliary freeze sensor protection acts similarly except with the temperature thresholds determined by the switch. See your dealer for details.

### CLEAN-UP CYCLE (OPTIONAL)

When a pump or blower is turned on by a button press, a clean-up cycle begins 30 minutes after the pump or blower is turned off or times out. The pump and the ozone generator will run for 30 minutes or more, depending on the system. On some systems, you can change this setting.

**TIME-OF-DAY**

**BE SURE TO SET THE TIME-OF-DAY**

Setting the time-of-day is important for determining filtration times and other background features. "Set Time" will appear on the display if no time-of-day is set in the memory. On the Settings Screen, select the Time-of-Day line. On the Time-of-Day screen, simply select the Hour, Minutes, and 12/24 Hour segments. Use the Up and Down Buttons to make changes.

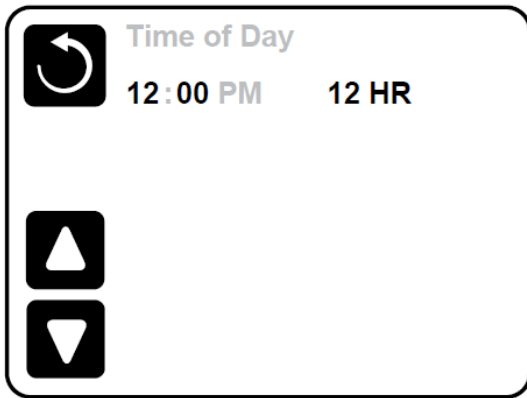

**NOTE:**

This only applies to some systems: If power is interrupted to the system, Time-of-Day will be maintained for several days.

**ADJUSTING FILTRATION**

**MAIN FILTRATION**

Using the same adjustment as Setting the Time, Filter Cycles are set using a start time and a duration. Each setting can be adjusted in 15-minute increments. The panel calculates the end time and displays it automatically.

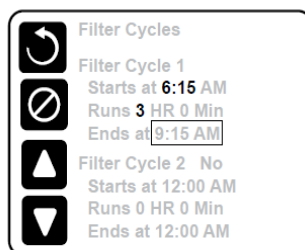
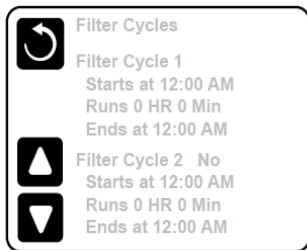

**FILTER CYCLE 2 - OPTIONAL FILTRATION**

Filter Cycle 2 is OFF by default. This displays as "No". When Filter Cycle 2 is ON it displays as "Yes". Press "Yes" or "No" to toggle Filter Cycle 2 ON or OFF. When Filter Cycle 2 is ON, it can be adjusted in the same manner as Filter Cycle 1. It is possible to overlap Filter Cycle 1 and Filter Cycle 2, which will shorten overall filtration by the overlap amount.

**CIRCULATION PUMP MODES**

Some spas may be manufactured with Circ Pump settings that allow programming filtration cycle duration. Some circ Modes are pre-programmed to operate 24 hours a day and are not programmable. Refer to the spa manufacturer's documentation for any Circ Mode details.

**PURGE CYCLES**

In order to maintain sanitary conditions, as well as protect against freezing, secondary water devices will purge water from their respective plumbing by running briefly at the beginning of each filter cycle. If the Filter Cycle 1 duration is set for 24 hours, enabling Filter Cycle 2 will initiate a purge when Filter Cycle 2 is programmed to begin.

**THE MEANING OF FILTER CYCLES**

1. The heating pump always runs during the filter cycle\*
2. In Rest Mode, heating only occurs during the filter cycle
3. Purges happen at the start of each filter cycle

For example, if your spa is set up for 24/hour circulation except for shutting off when the water temperature is 3°F/1.3°C above the set temperature, that shutoff does not occur during filter cycles.

**ADDITIONAL SETTINGS**

**LIGHT CYCLE OPTION**

If Light Cycle does not appear in the Settings Menu, the Light Timer feature is not enabled by the manufacturer. When available, the Light Timer is OFF by default. The settings can be edited the same way that Filter Cycles are edited.

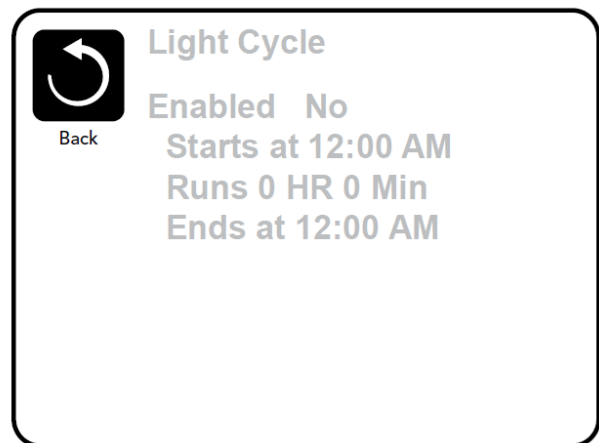

**INVERT PANEL**

Selecting Invert Panel will flip the display and the buttons so the panel can be easily operated from inside or outside the hot tub.

**AUXILIARY PANEL(S)**

**SPECIFIC BUTTONS FOR SPECIFIC DEVICES**

If the spa has an Auxiliary Panel(s) installed, pressing buttons on that panel will activate the device indicated for that button. These dedicated buttons will operate just like the Spa Screen buttons and the equipment will behave in the same manner with each button press.

**RESTRICTING OPERATION**

The control can be restricted to prevent unwanted use or temperature adjustments. Locking the Panel prevents the controller from being used, but all automatic functions are still active. Locking the Settings allows Jets and other features to be used, but the Set Temperature and other programmed settings cannot be adjusted. Settings Lock allows access to a reduced selection of menu items. These include Filter Cycles, Invert, Information and Fault Log. They can be seen, but not changed or edit

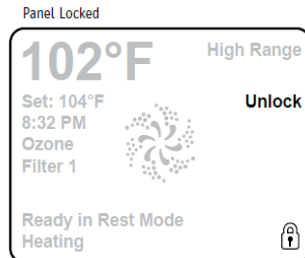
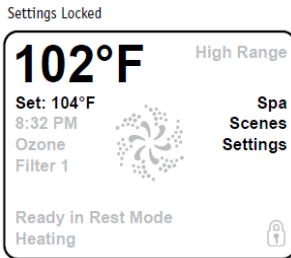
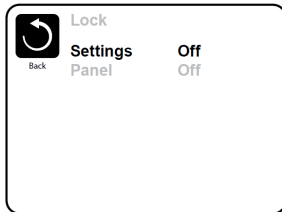

**UNLOCKING**

To unlock either Settings or Panel first select Settings (if it says "On") or Panel (if it says "On"), then press in the middle of the screen for at least 5 seconds.

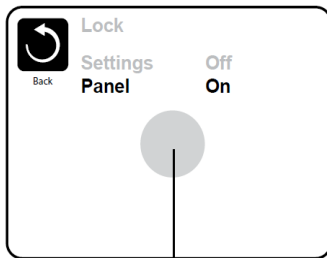

Press here for 5 seconds to unlock

**SCENES**

**WHAT ARE SCENES?**

Scenes are stored combinations of equipment states. For example if you want to have Pump 1 at high speed and Pump 2 at low speed and the Light ON, you could store that in a Scene and recall this combination at any time.



This appears once the Scene has been stored

**STORING A SCENE**

Press a Scene number and hold until "Scene stored" appears at the bottom of the screen to save the current equipment combination.

**RECALLING A SCENE**

To recall a Scene simply press a Scene number. Pressing any Scene line which has not yet been stored will simply turn off all spa devices.

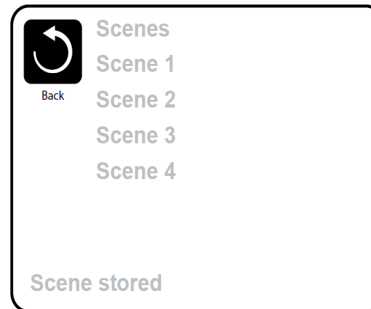

**ADDITIONAL SETTINGS**

**HOLD MODE - M037\***

Hold Mode is used to disable the pumps during service functions like cleaning or replacing the filter. Hold Mode will last for 1 hour unless the mode is exited manually. If spa service will require more than an hour, it may be best to simply shut down power to the spa.

**DRAIN MODE**

Some spas have a special feature that allows Pump 1 to be employed when draining the water. When available, this feature is a component of Hold Mode.

**UTILITIES**

The Utilities Menu contains the following:

**A/B TEMPS**

When this is set to On, the main screen will display sensor A and sensor B temperatures simultaneously. Sensor A is at the opposite end of the heater from sensor B.

**DEMO MODE**

Demo Mode is not always enabled, so it may not appear. This is designed to operate several devices in a sequence in order to demonstrate the various features of a particular hot tub.

**FAULT LOG**

The Fault Log is a record of the last 24 faults that can be reviewed by a service tech. Use the Up and Down buttons to view each of the Faults. When Priming Mode shows in the Fault Log, it is not a fault. Rather, it is used to keep track of spa restarts.

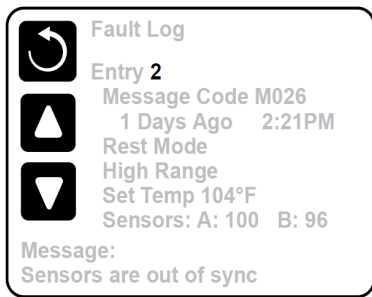

**GFCI TEST**

(Feature not available on CE rated systems.)

Your systems may have GFCI configured in one of three ways:

1. GFCI test is not enabled
2. Manual GFCI test is enabled but automatic GFCI test is not enabled
3. Both manual and automatic GFCI tests are enabled. The automatic test will happen within 7 days of the spa being installed and if successful will not repeat. (If the automatic test fails it will repeat after the spa is restarted.) GFCI Test will not appear on the screen if it is not enabled. This screen allows the GFCI to be tested manually from the panel and can be used to reset the automatic test feature.

\*M0XX is a Message Code. Codes like this will be seen in the Fault Log

**ADDITIONAL SETTINGS**

**PREFERENCES**

The Preferences Menu allows the user to change certain parameters based on personal preference.

**TEMP DISPLAY**

Change the temperature between Fahrenheit and Celsius.

**TIME DISPLAY**

Change the clock between 12 hr and 24 hr display.

**REMINDERS**

Turn the reminder messages (like "Clean Filter") On or Off.

**CLEANUP**

Cleanup Cycle Duration is not always enabled, so it may not appear. When it is available, set the length of time Pump 1 will run after each use. 0-4 hours are available.

**DOLPHIN II AND DOLPHIN III (APPLIES TO RF DOLPHIN ONLY)**

When set to 0, no addressing is used. Use this setting for a Dolphin II or Dolphin III which is factory set for no address by default. When set between 1 and 7, the number is the address. (See the Dolphin manual for details.)

**COLOR**

Selecting Color will cycle through 5 background colors available in the control.

**LANGUAGE**

Change the language displayed on the panel.

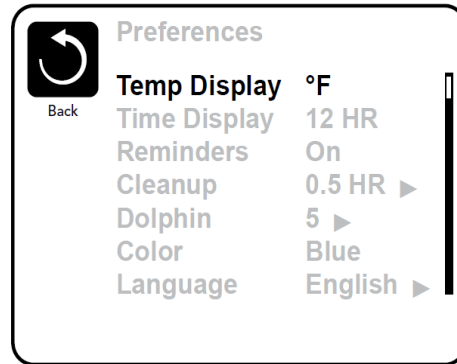

**INFORMATION**

**SYSTEM INFORMATION**

The System Information Menu displays various settings and identification of the particular system. As each item in the menu is selected, the detail for that item is displayed at the bottom of the screen.

**SOFTWARE ID (SSID)**

Displays the software ID number for the System.

**SYSTEM MODEL**

Displays the Model Number of the System.

**CURRENT SETUP**

Displays the currently selected Configuration Setup Number.

**CONFIGURATION SIGNATURE**

Displays the checksum for the system configuration file.

**HEATER VOLTAGE  
(FEATURE NOT USED ON CE RATED SYSTEMS.)**

Displays the operating voltage configured for the heater.

**HEATER WATTAGE AS CONFIGURED IN SOFTWARE  
(CE SYSTEMS ONLY.)**

Displays a heater kilowatt rating as programmed into the control system software (1-3 or 3-6).

**HEATER TYPE**

Displays a heater type ID number.

**DIP SWITCH SETTINGS**

Displays a number that represents the DIP switch positions of S1 on the main circuit board.

**PANEL VERSION**

Displays a number of the software in the topside control panel.

**FORCING THE GFCI TRIP TEST (NORTH AMERICA ONLY)**

The installer can cause the GFCI Trip Test to occur sooner by initiating it using the above menu. The GFCI should trip within several seconds and the spa should shut down. If it does not, shut down the power and manually verify that a GFCI breaker is installed and that the circuit and spa are wired correctly. Verify the function of the GFCI with its own test button. Restore power to the spa and repeat the GFCI Trip Test. Once the GFCI is tripped by the test, reset the GFCI and the spa will operate normally from that point. You can verify a successful test by navigating to the above menu. "Passed" should appear after the Reset line is selected on the GFCI screen.

**WARNING:**

On those systems that automatically test the GFCI within 1 to 7 days after startup: The end-user must be trained to expect this one-time test to occur. The end-user must be trained how to properly reset the GFCI. If freezing conditions exist, the GFCI or RCD should be reset immediately or spa damage could result.

**CE PRODUCT:**

CE registered systems do not have an RCD Test Feature due to the nature of the electrical service. Some UL registered systems do not have the GFCI Test Feature activated. The end-user must be trained how to properly test and reset the RCD.

**GENERAL MESSAGES**

Most messages and alerts will appear at the bottom of the normally used screens. Several alerts and messages may be displayed in a sequence.

**WATER TEMPERATURE IS UNKNOWN**

After the pump has been running for 1 minute, the temperature will be displayed.

**POSSIBLE FREEZING CONDITION**

A potential freeze condition has been detected, or the Aux Freeze Switch has closed. All water devices are activated. In some cases, pumps may turn on and off and the heater may operate during Freeze Protection. This is an operational message, not an error indication.

**THE WATER IS TOO HOT – M029\***

The system has detected a spa water temp of 110°F (43.3°C) or more, and spa functions are disabled. System will auto reset when the spa water temp is below 108°F (42.2°C). Check for extended pump operation or high ambient temp.

**HEATER-RELATED MESSAGES**

**THE WATER FLOW IS LOW – M016\*\***

There may not be enough water flow through the heater to carry the heat away from the heating element. Heater start up will begin again after about 1 min. See "Flow Related Checks" below.

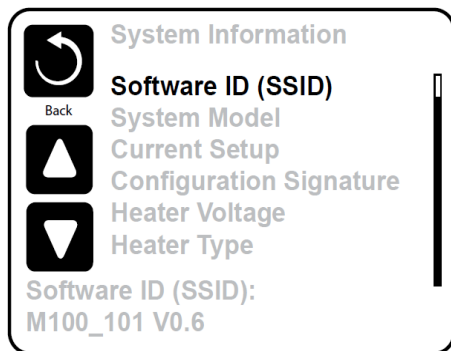

**UTILITIES – GFCI TEST FEATURE**

The Ground Fault Circuit Interrupter (GFCI) or Residual Current Detector (RCD) is an important safety device and is required equipment on a hot tub installation. **(The GFCI Test Feature is not available on CE rated systems.)**

**USED FOR VERIFYING A PROPER INSTALLATION**

Your spa may be equipped with a GFCI Protection feature. If your spa has this feature enabled by the manufacturer, the GFCI Trip Test must occur to allow proper spa function.

**ON SOME SYSTEMS:**

Within 1 to 7 days after startup, the spa will trip the GFCI to test it. (The number of days is factory programmed.) The GFCI must be reset once it has tripped. After passing the GFCI Trip Test, any subsequent GFCI trips will indicate a ground fault or other unsafe condition and the power to the spa must be shut off until a service person can correct the problem.

**THE WATER FLOW HAS FAILED\* – M017\*\***

There is not enough water flow through the heater to carry the heat away from the heating element and the heater has been disabled. See “Flow Related Checks” below. After the problem has been resolved, reset the message\*.

**THE HEATER MAY BE DRY\* – M028\*\***

Possible dry heater, or not enough water in the heater to start it. The spa is shut down for 15 min. Reset this message\* to reset the heater start-up. See “Flow Related Checks” below.

**THE HEATER IS DRY\* – M027\*\***

There is not enough water in the heater to start it. The spa is shut down. After the problem has been resolved, you must reset the message\* to restart heater start up. See “Flow Related Checks” below.

**THE HEATER IS TOO HOT\* – M030\*\***

One of the water temp sensors has detected 118°F (47.8°C) in the heater and the spa is shut down. You must reset the message\* when water is below 108°F (42.2°C). See “Flow Related Checks” below.

**FLOW-RELATED CHECKS**

Check for low water level, suction flow restrictions, closed valves, trapped air, too many closed jets and pump prime. On some systems, even when spa is shut down by an error condition, some equipment may occasionally turn on to continue monitoring temperature or if freeze protection is needed.

\*M0XX is a Message Code. Codes like this will be seen in the Fault Log **Some messages can be reset from the panel.** Messages that can be reset will appear with a “right arrow” at the end of the message. Press the message text to reset the message.

**SENSOR-RELATED MESSAGES**

**SENSORS ARE OUT OF SYNC – M015\*\***

The temperature sensors MAY be out of sync by 3°F. Call for Service.

**SENSORS ARE OUT OF SYNC – CALL FOR SERVICE\* – M026\*\***

The temperature sensors ARE out of sync. The fault above has been established for at least 1 hour. Call for Service.

**SENSOR A FAULT, SENOR B FAULT – SENSOR A: M031\*\*, SENSOR B: M032\*\***

A temperature sensor or sensor circuit has failed. Call for Service.

**MISCELLANEOUS MESSAGES**

**COMMUNICATIONS ERROR**

The control panel is not receiving communication from the System. Call for Service.

**TEST SOFTWARE INSTALLED**

The Control System is operating with test software. Call for Service.

**°F OR °C IS REPLACED BY °T**

The Control System is in Test Mode. Call for Service.

\*\*M0XX is a Message Code. Codes like this will be seen in the Fault Log

**SYSTEM-RELATED MESSAGES**

**PROGRAM MEMORY FAILURE\* – M022\*\***

At Power-Up, the system has failed the Program Checksum Test. This indicates a problem with the firmware (operation program) and requires a service call.

**THE CLOCK HAS FAILED\* – M020\*\***

Contact your dealer or service organization.

**THE GFCI TEST FAILED (SYSTEM COULD NOT TEST THE GFCI) – M036\*\***

(North America Only) May indicate an unsafe installation. Contact your dealer or service organization.

**HOT FAULT – M035\*\***

A Pump Appears to have been Stuck ON when spa was last powered POWER DOWN THE SPA. DO NOT ENTER THE WATER. Contact your dealer or service organization.

**A PUMP MAY BE STUCK ON – M034\*\***

Water may be overheated. POWER DOWN THE SPA. DO NOT ENTER THE WATER. Contact your dealer or service organization.

**CONFIGURATION ERROR (SPA WILL NOT START UP)**

Contact your dealer or service organization.

**THE SETTINGS HAVE BEEN RESET (PERSISTENT MEMORY ERROR)\* – M021\*\***

Contact your dealer or service organization if this message appears on more than one power-up.

**REMINDER MESSAGES**

**GENERAL MAINTENANCE HELPS.**

Reminder Messages can be suppressed by using the Preferences Menu. Reminder Messages can be chosen individually by the Manufacturer. They may be disabled entirely, or there may be a limited number of reminders on a specific model. The frequency of each reminder (i.e. 7 days) can be specified by the Manufacturer.

**CHECK THE PH**

May appear on a regular schedule, i.e. every 7 days. Check pH with a test kit and adjust pH with the appropriate chemicals.

**CHECK THE SANITIZER**

May appear on a regular schedule, i.e. every 7 days. Check sanitizer level and other water chemistry with a test kit and adjust with the appropriate chemicals.

### CLEAN THE FILTER

May appear on a regular schedule, i.e. every 30 days. Clean the filter media as instructed by the manufacturer.

*Additional messages may appear on specific systems.*

### TEST THE GFCI (OR RCD)

May appear on a regular schedule, i.e. every 30 days. The GFCI or RCD is an important safety device and must be tested on a regular basis to verify its reliability. Every user should be trained to safely test the GFCI or RCD associated with the hot tub installation. A GFCI or RCD will have a TEST and RESET button on it that allows a user to verify proper function.

### CHANGE THE WATER

May appear on a regular schedule, i.e. every 90 days. Change the water in the spa on regular basis to maintain proper chemical balance and sanitary conditions.

### CLEAN THE COVER

May appear on a regular schedule, i.e. every 180 days. Vinyl covers should be cleaned and conditioned for maximum life.

### TREAT THE WOOD

May appear on a regular schedule, i.e. every 180 days. Wood skirting and furniture should be cleaned and conditioned per the manufacturers instructions for maximum life.

### CHANGE THE FILTER

May appear on a regular schedule, i.e. every 365 days. Filters should be replaced occasionally to maintain proper spa function and sanitary conditions.

**Additional messages may appear on specific systems.**

**Reminder messages can be reset from the panel.** Messages that can be reset will appear with a "right arrow" at the end of the message. Press the message text to reset the message.



Warning! Qualified Technician Required for Service and Installation



**PANEL REMOVAL INSTRUCTIONS**

**REMOVING YOUR COAST SPA PANEL TO ACCESS EQUIPMENT**

- 1. Start by removing the three screws at the bottom of the panel (Illustration 1). These screws will be covered with a cap. To remove the cap, use a flat head screw driver on the bottom edge of the cap. Place the screw driver between the cap and the spa and simply twist screw driver to remove cap. Using a Robertson tip screw driver, remove the three screws.
- 2. After removing the three screws, grasp bottom outer edges of the panel and pull firmly towards your body to release the Panel Clips. Ensure not to pull too hard as you could potentially break the clips (Illustration 2).
- 3. After releasing the clips, lower the panel to the ground. If your Spa is equipped with an Obsidian Display, there will be three wires to disconnect (Illustration 3).

**RE-INSTALLING THE PANEL**

- 1. Hold the bottom edge of the panel and insert the top edge under the lip of the spa. Center and align horizontally with the Spa to position the Clips.
- 2. Once aligned, apply pressure to both sides of the panel re-securing the clips. This does not require a lot of pressure and should click together easily.

**Illustration 1**

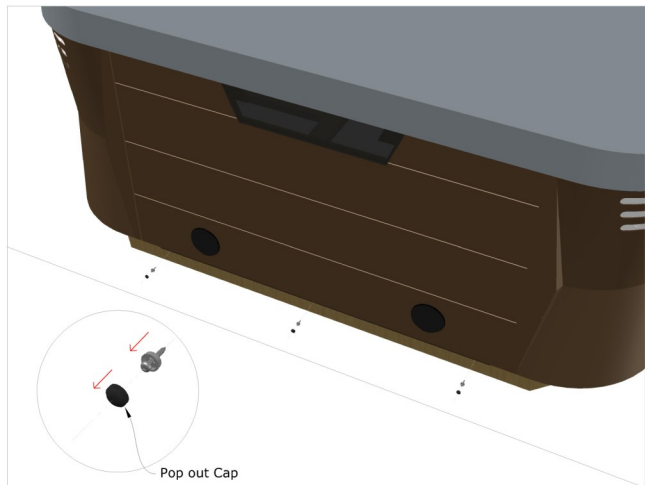

**Illustration 2**

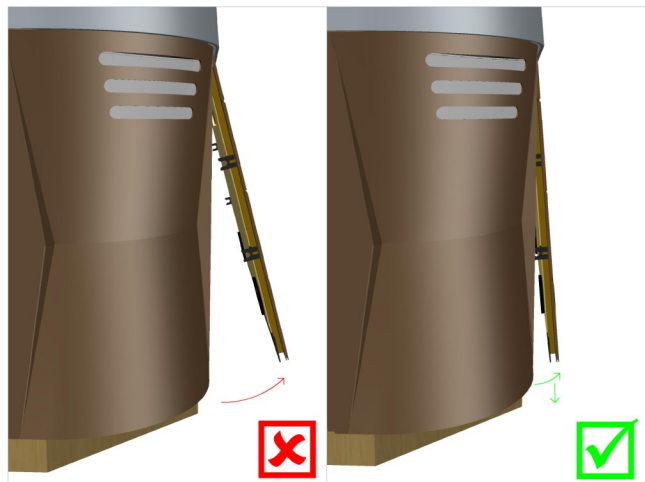

**Illustration 3**

